

Proposal of RoF Relay Backhaul for Category 4

Authors:

Date: 2013-09-18

Name	Affiliations	Address	Phone	email
Tetsuya Kawanishi	NICT	Koganei, Japan		kawanisi@nict.go.jp
Atsushi Kanno	NICT	Koganei, Japan		kanno@nict.go.jp
Hiroyo Ogawa	NICT	Koganei, Japan		mmwthzhogawa@nict.go.jp
Nobuhiko Shibagaki	Hitachi	Kokubunji, Japan		nobuhiko.shibagaki.qr@hitachi.com
Hiroshi Hanyu	Hitachi	Kawasaki, Japan		hiroshi.hanyu.pq@hitachi.com

Abstract

RoF (Radio on Fiber) relay link is proposed as one of usage models of 11aj backhaul. RoF relay link can extend wireless access area to the different location without additional requirements. RoF relay link has broadband transmission capability because of O/E and E/O broadband conversion characteristics and can transmit signals at 45-GHz and 60-GHz bands simultaneously.

The aim of this contribution is to add usage model 4c in the IEEE 802.11aj Usage Models Document IEEE 802.11-12/1145r4.

Overview of WFA VHT usage models for 802.11ad

Category	#	Usage Model
1.Wireless Display	1a	Desktop Storage & Display
	1b	Projection to TV or Projector in Conf Rom
	1c	In room Gaming
	1d	Streaming from Camcorder to Display
	1e	Broadcast TV Field Pick Up
	1f	Medical Imaging Surgical Procedure Support
2.Distribution of HDTV	2a	Lightly compressed video streaming around home
	2b	Compr. video steaming in a room/ t.o. home
	2c	Intra Large Vehicle (e.g. airplane) Applications
	2d	Wireless Networking for Small Office
	2e	Remote medical assistance
3.Rapid Upload / Download	3a	Rapid Sync-n-Go file transfer
	3b	Picture by Picture viewing
	3c	Airplane docking
	3d	Movie Content Download to car
	3e	Police / Surveillance Car Upload
4.Backhaul	4a	Multi-Media Mesh backhaul
	4b	Point to Point backhaul
5.Outdoor Campus /Auditorium	5a	Video demos / telepresence in Auditorium
	5b	Public Safety Mesh
6.Manufacturing Floor	6a	Manufacturing floor automation
7.Cordless computing	7a	Wireless IO / Docking

Category 4: Backhaul

a. Multi-Media Mesh Backhaul

- Hotspot
- Enterprise
- Small Office or Home
- Campus-wide deployments
- Municipal deployments

b. Point-to-Point Backhaul

c. RoF* Relay Backhaul

* Radio on Fiber

Usage Model 4c: RoF Relay Backhaul

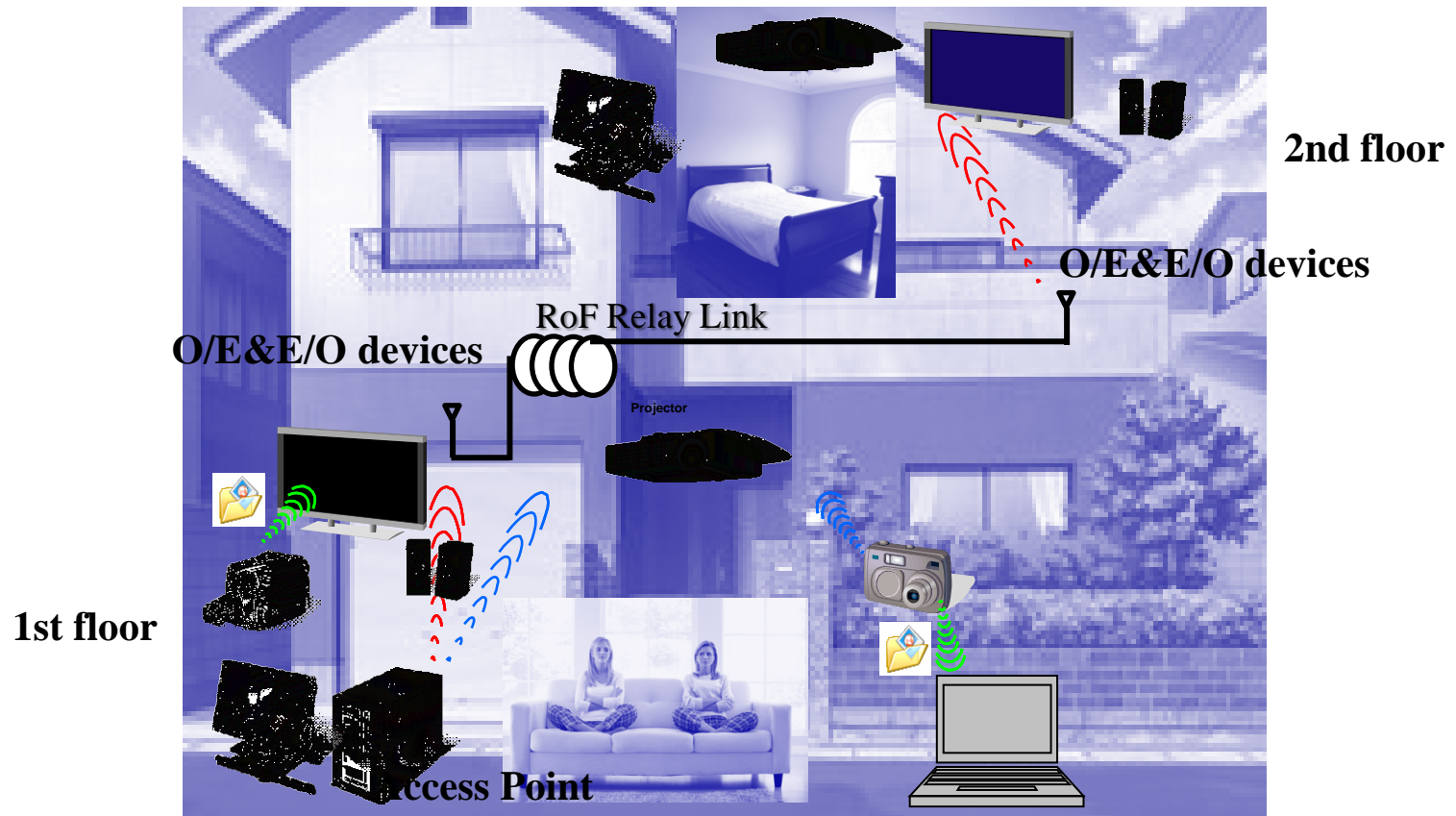

Although this example shows the relay link between the first and the second floors in the house, the idea of the relay link can be extended to connection between rooms in the apartment, hospital, school, factory and etc.

In-Building RoF Relay Link for WLAN

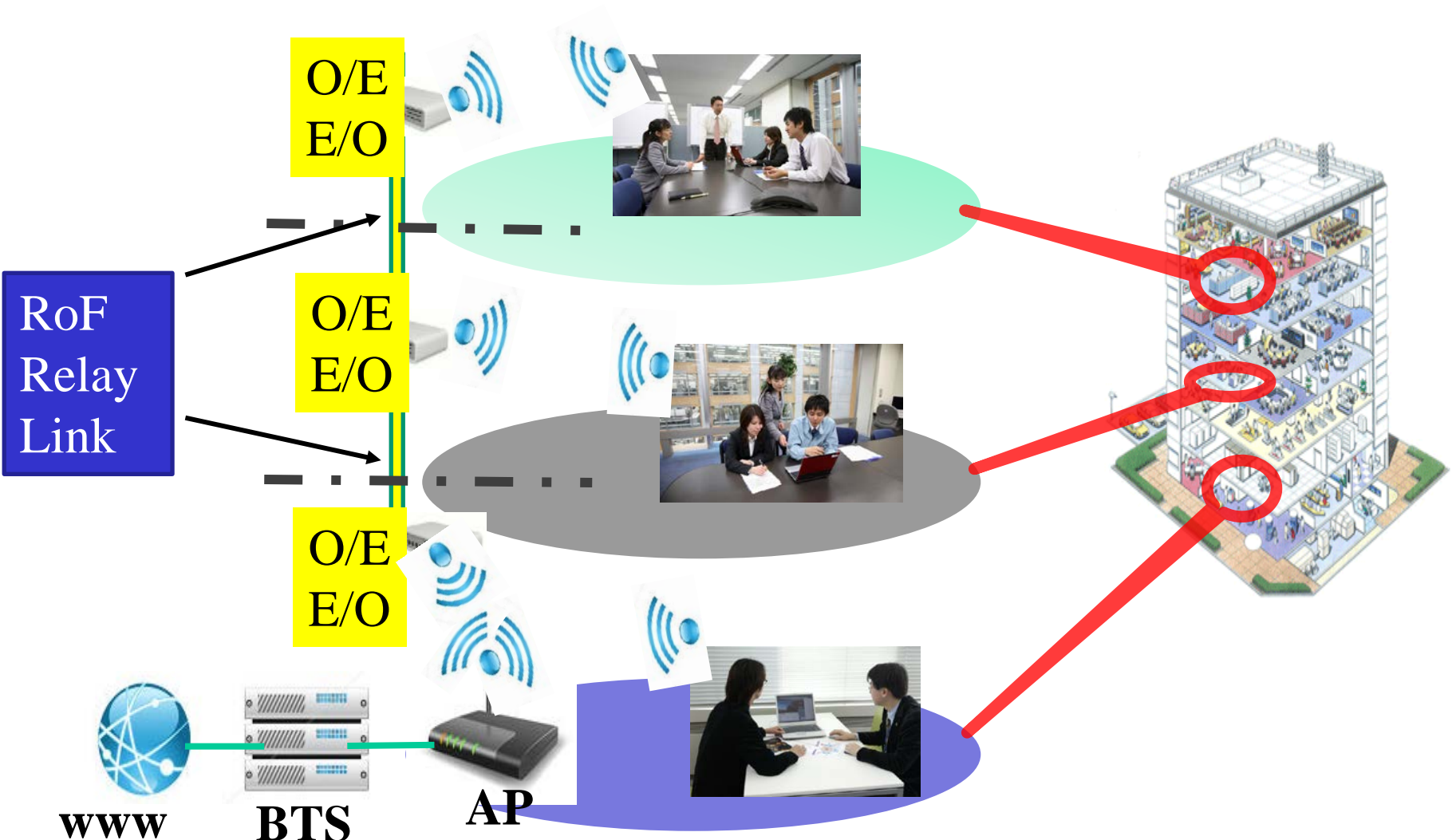

WWW

BTS

AP

Wi-Fi Miracast™ and Wi-Fi Direct™ connection at home environment using RoF Relay Link

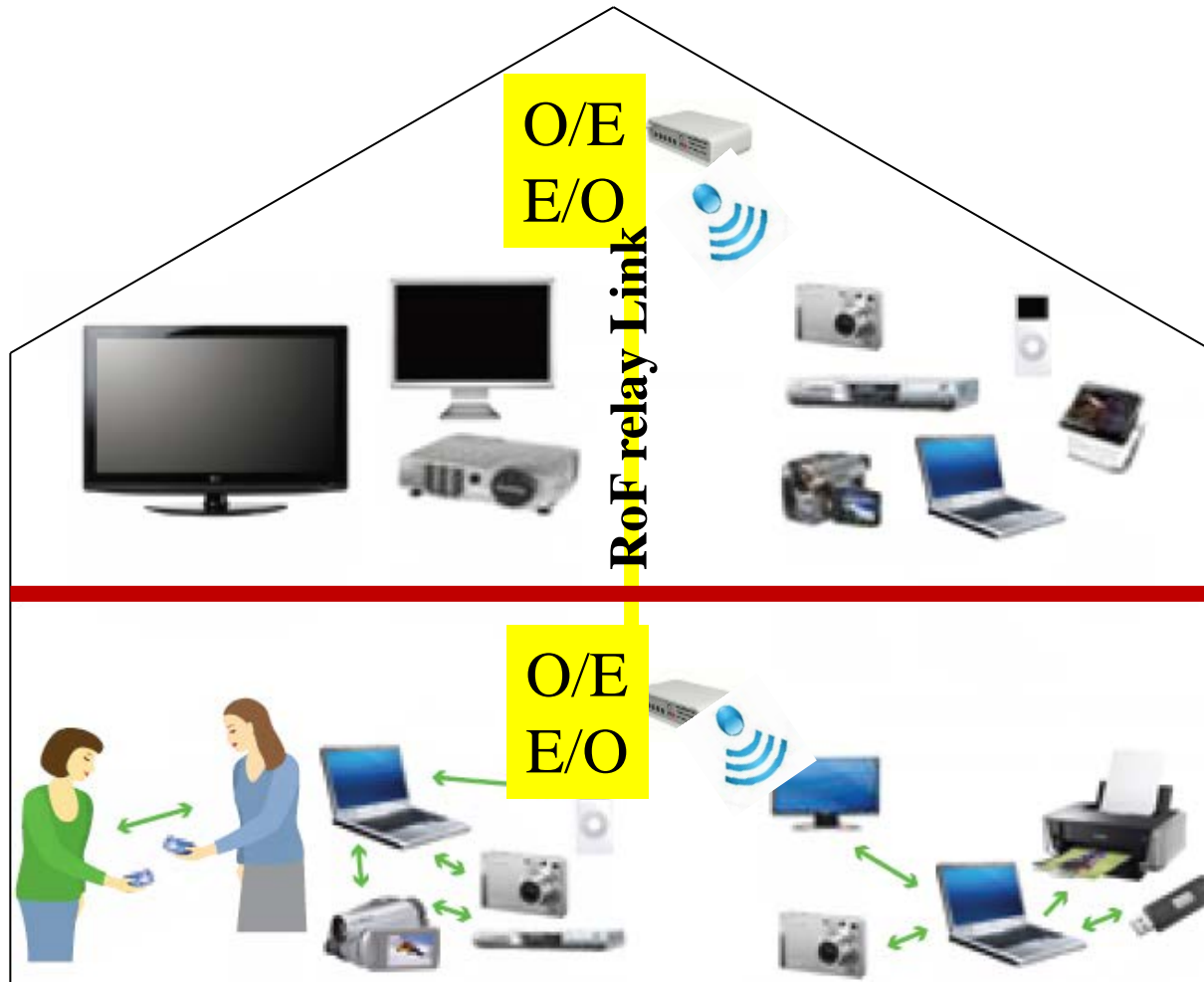

45 GHz and 60 GHz frequencies cannot penetrate walls, floors and ceilings in the buildings.

Usage Model 4c: RoF Relay Backhaul

Pre-Conditions:

Wireless zones are connected via RoF relay link. The individual wireless zones can support high-speed-data traffic requirements that are limited by the VHT link capabilities.

Application:

Traffic is bidirectional and is comprised of subcarriers which include data, voice, video, and any kinds of signals. These subcarriers are radio frequencies, i.e. either 45GHz or 60 GHz bands. RoF relay link extends coverage areas without any performance degradation and any changes of traffic requirements.

Environment:

Environment can be home, office, manufacturing floor, etc. The RoF relay link distance can be extended up to 200 m due to latency of E/O and O/E conversions. Typical locations which are connected via optical fiber cables are electromagnetically isolated from the area covered by the access point. No degradation of system characteristics can be managed by use of RoF relay link.

Traffic Conditions:

RoF relay link can carry any type of traffic due to broadband transmission capability and linear characteristics of E/O and O/E devices. No additional traffic conditions are introduced by RoF relay link.

Use Case:

1. Wirelessly separated spaces such as rooms of houses surrounded by concretes are directly connected through RoF relay link without any digital signal processing units of relay stations.
2. In spite of physical and electromagnetic separation, one wireless zone is extended to another wireless zone which can include the same stations of the original wireless zones.
3. Users at different locations can take advantage of broadband multi-media applications.

Experimental Setup 1 : Frequency Response of RoF Link

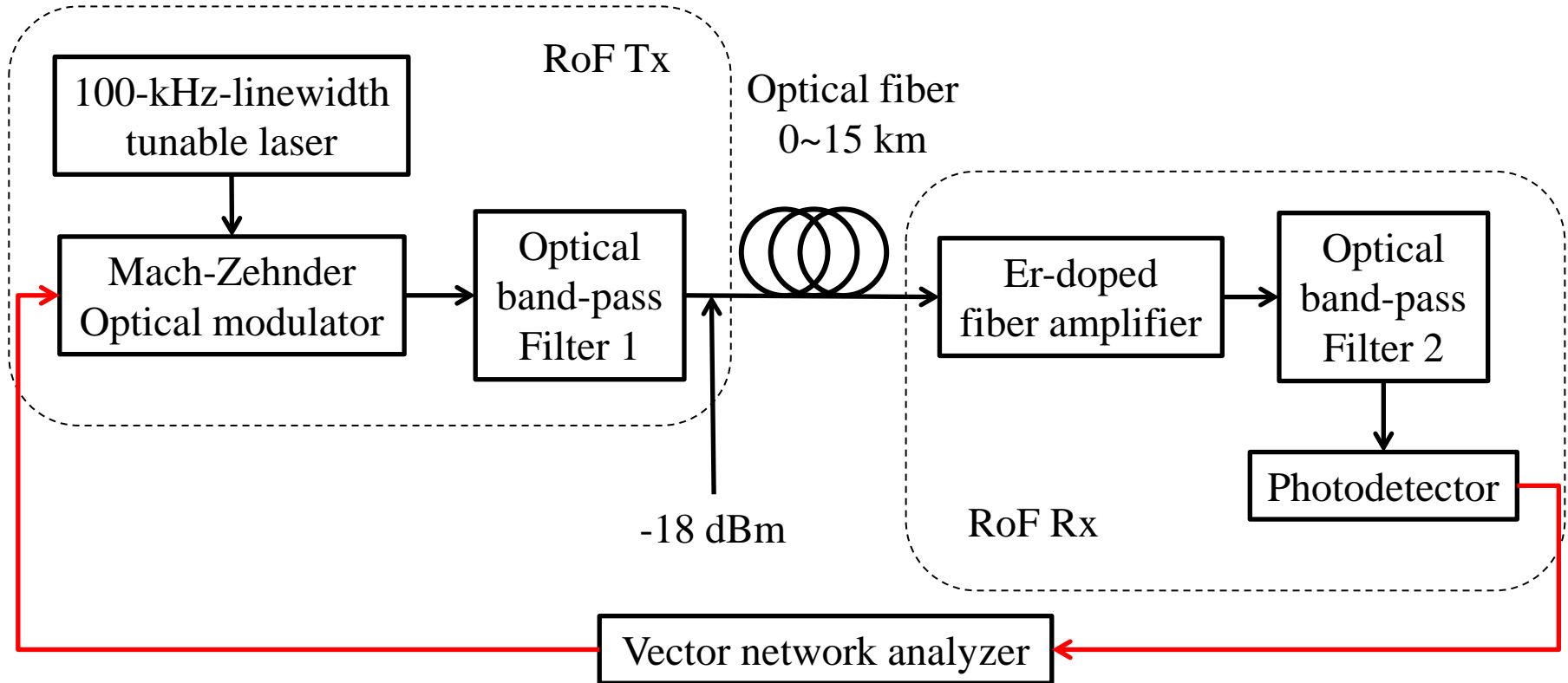

Tunable laser: Yenista optics OSICS TLS-AG (Power stability: ± 0.03 dB)

MZ modulator: GIGOPTIX LX8901 (3-dB BW: > 65 GHz)

Photodetector: u2t photonics XPDV4120 (3-dB BW: 100 GHz)

EDFA: Amonics Burst-mode EDFA (Sat. power 20 dBm, NF: < 5.5 dB)

Bandpass filter1: BW > 1 nm for generation of single sideband signal

Bandpass filter2: BW ~ 1 nm for suppression of ASE noises from EDFA

Subcarrier Transmission of RoF Relay Link

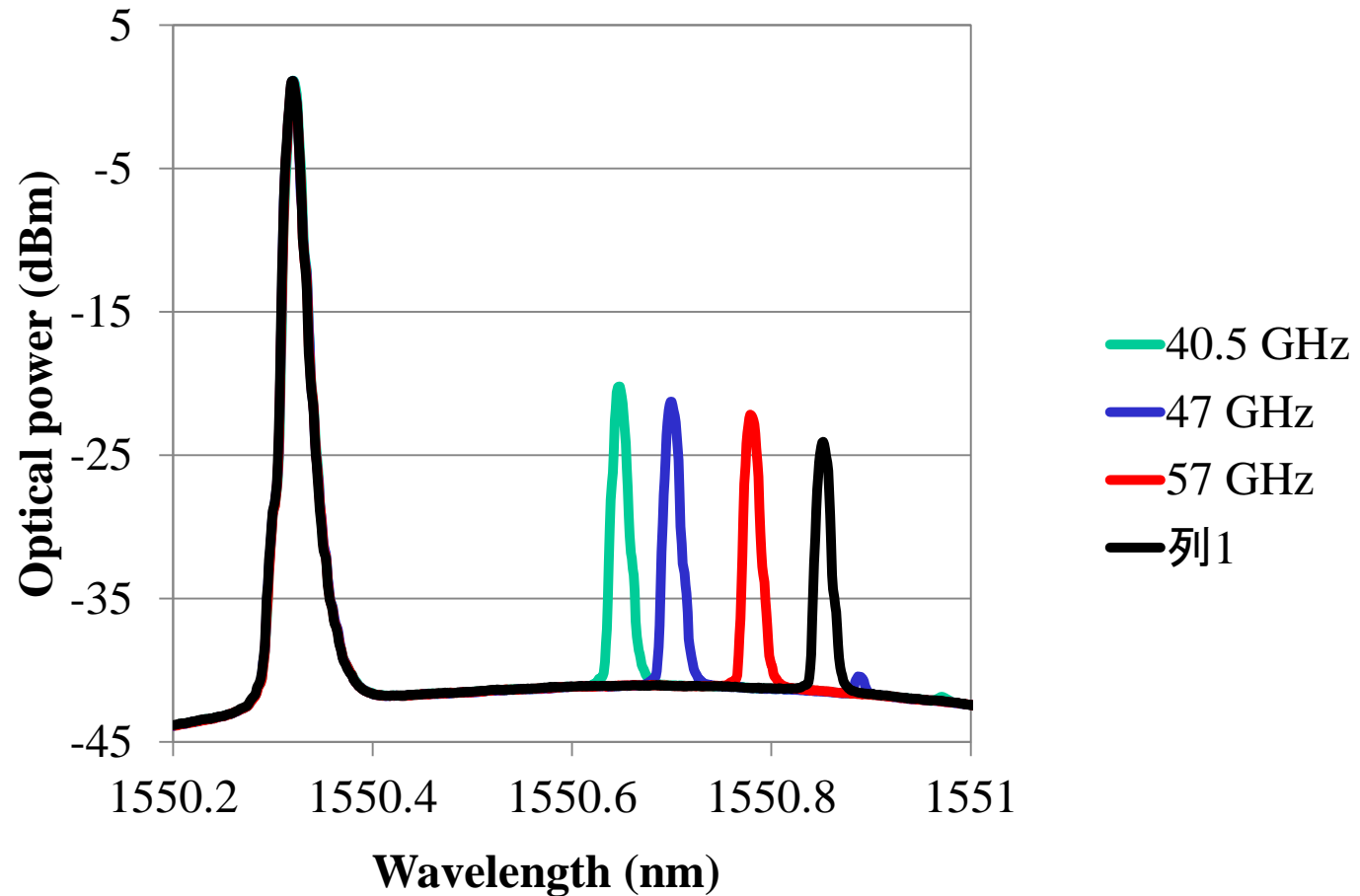

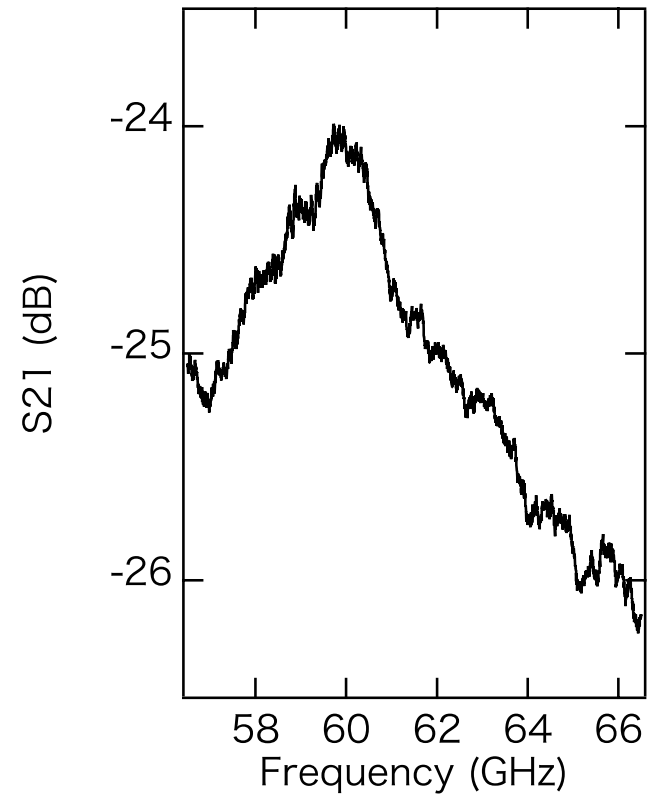
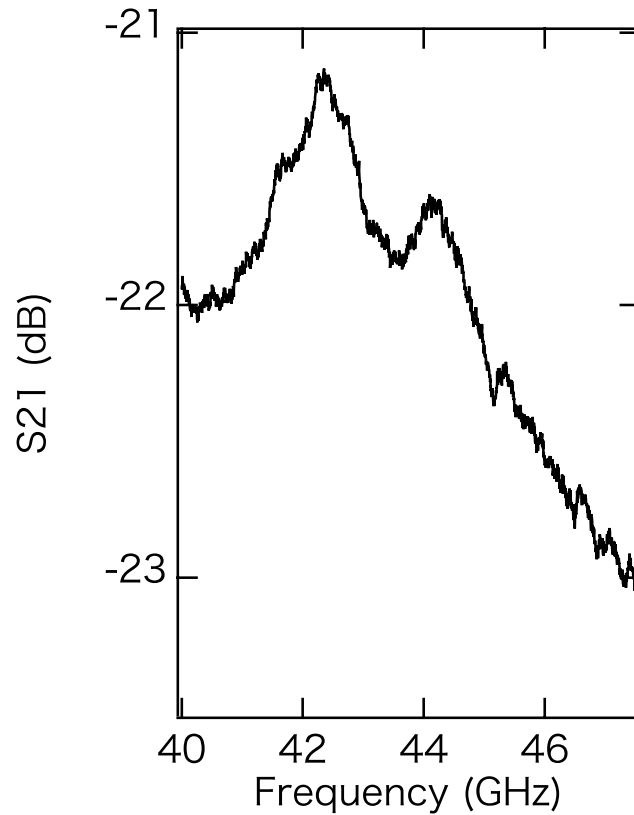

Amplitude Deviation: < 2 dBp-p at 40.5-47 GHz
~ 2 dBp-p at 57-66 GHz

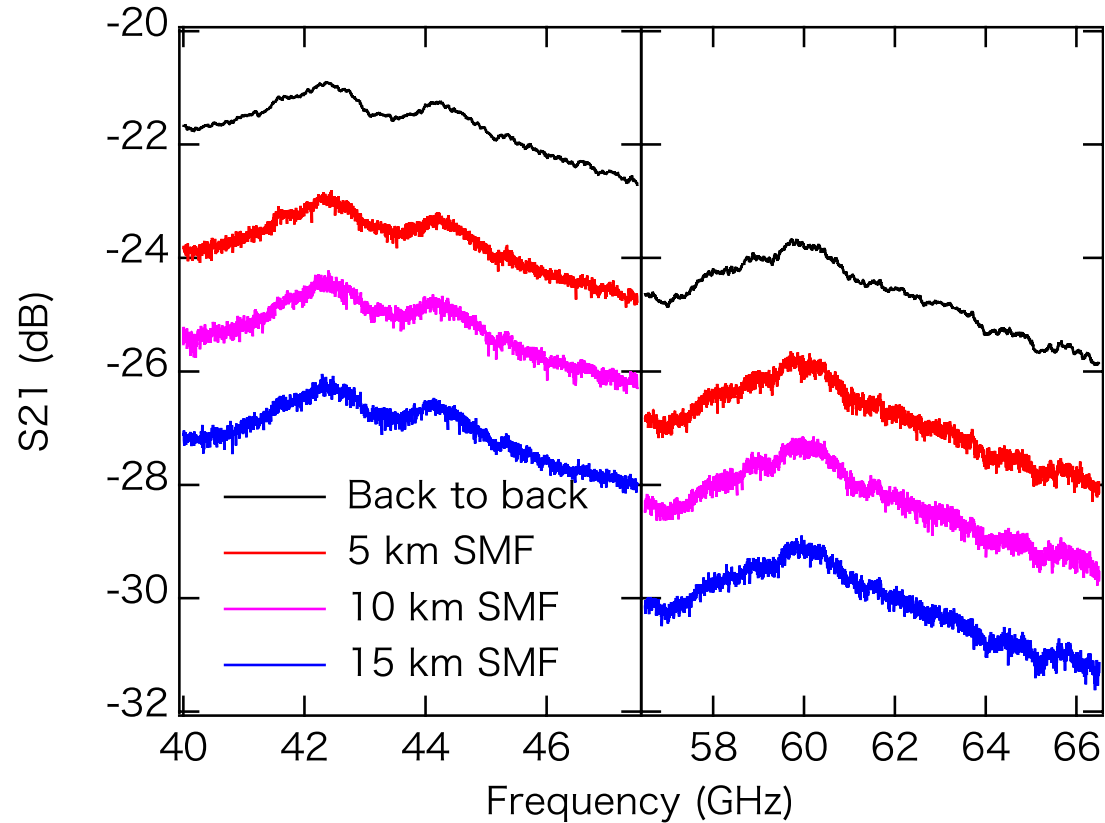

Frequency response of RoF link at 40-48 GHz and 56-67 GHz bands

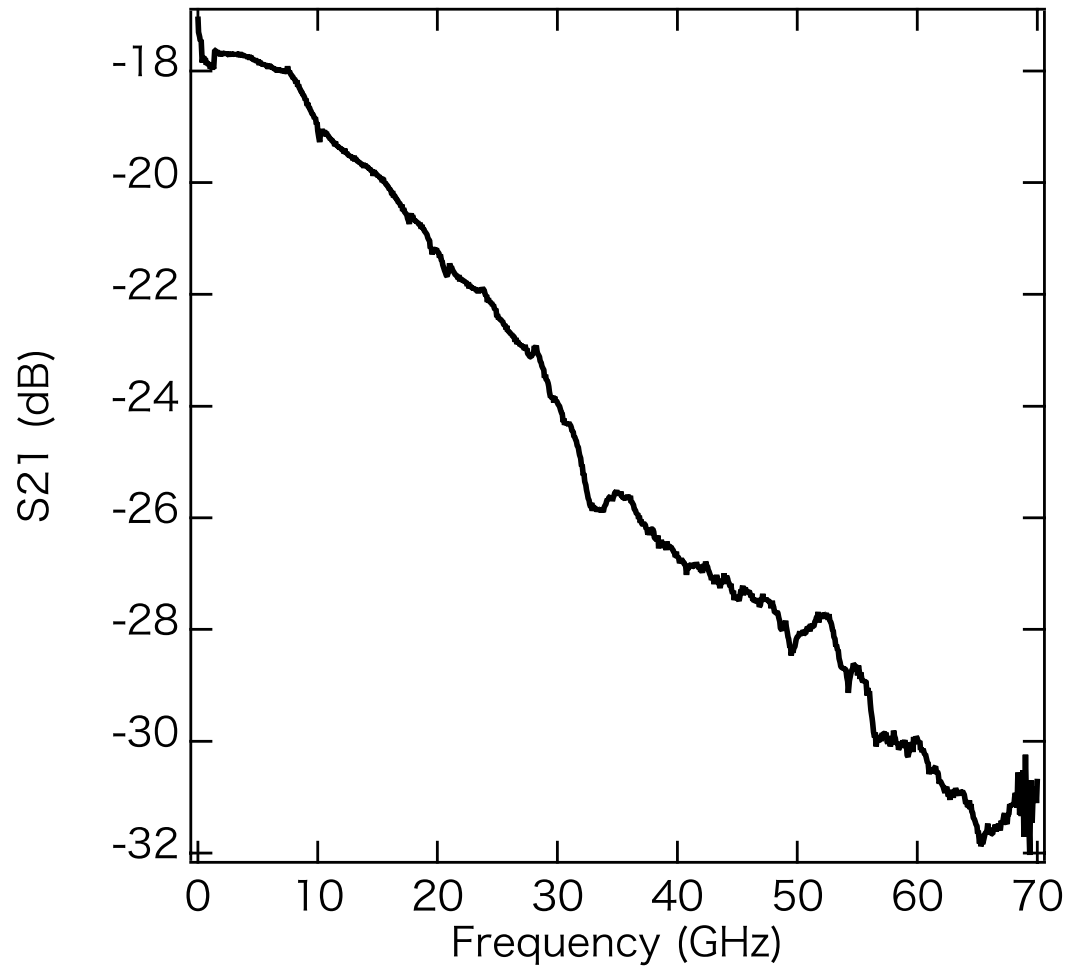

Measured link loss:
~ -28 dB @ 40GHz
~ -31 dB @ 60GHz

Broadband frequency characteristics of RoF link

Experimental Setup 2 : Single-Side-Band Modulated Signal Transmission of RoF Relay Link using IEEE802.11ad Signal

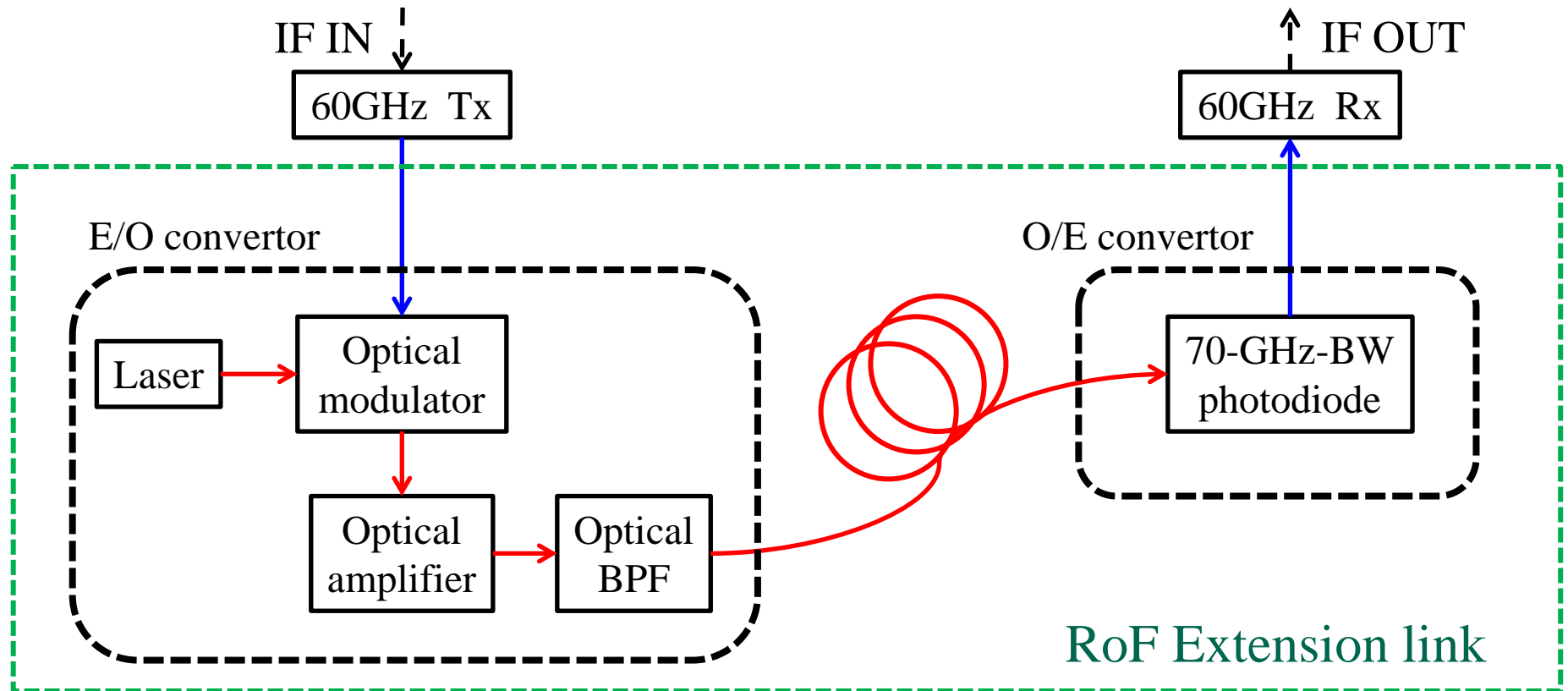

— Coaxial cable

— Optical fiber

60-GHz $\pi/2$ -BPSK Signal Transmission Experimental Results (1)

RF Back to Back

180m RoF Extension link

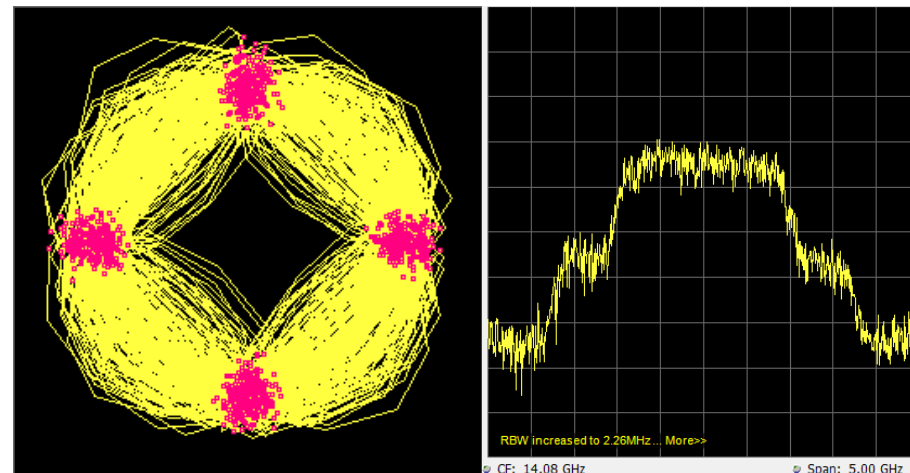
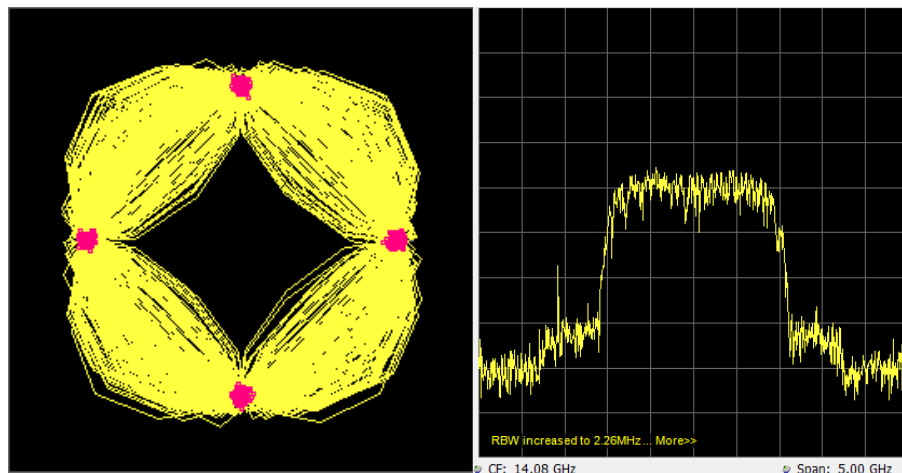

EVM: 3.3% (-29.6dB)

EVM: 12.7% %(-17.9dB)

60-GHz $\pi/2$ -BPSK Signal Transmission

Experimental Results (2)

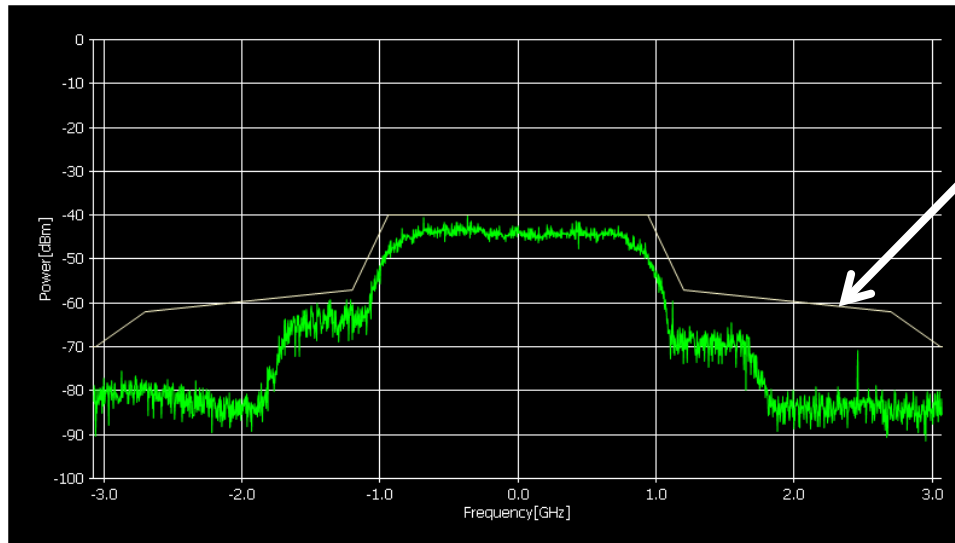

Required spectrum
mask at channel 4
of 802.11ad

Ch.4 ($f_c=64.80$ GHz)

60-GHz 16QAM Signal Transmission Experimental Results

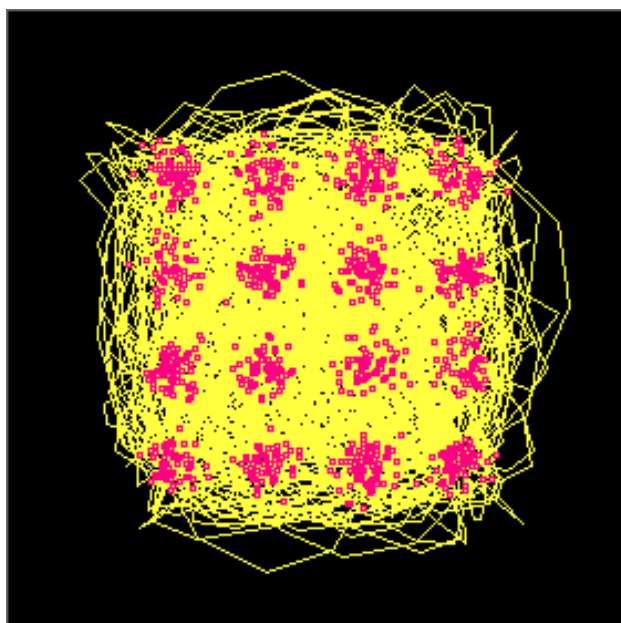

EVM : 14% (-17dB)

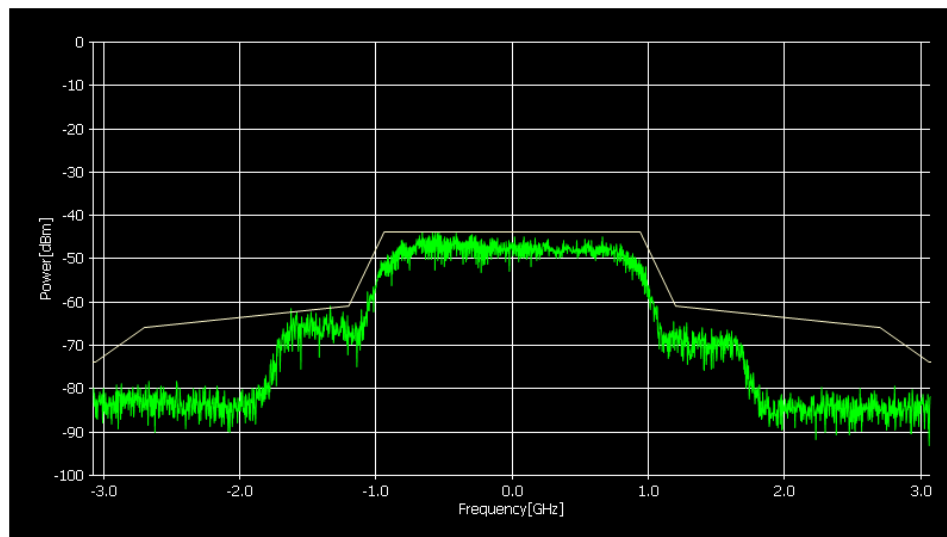

Ch.4 (fc=64.80 GHz)

EVM (Error Vector Magnitude) vs. Fiber Length

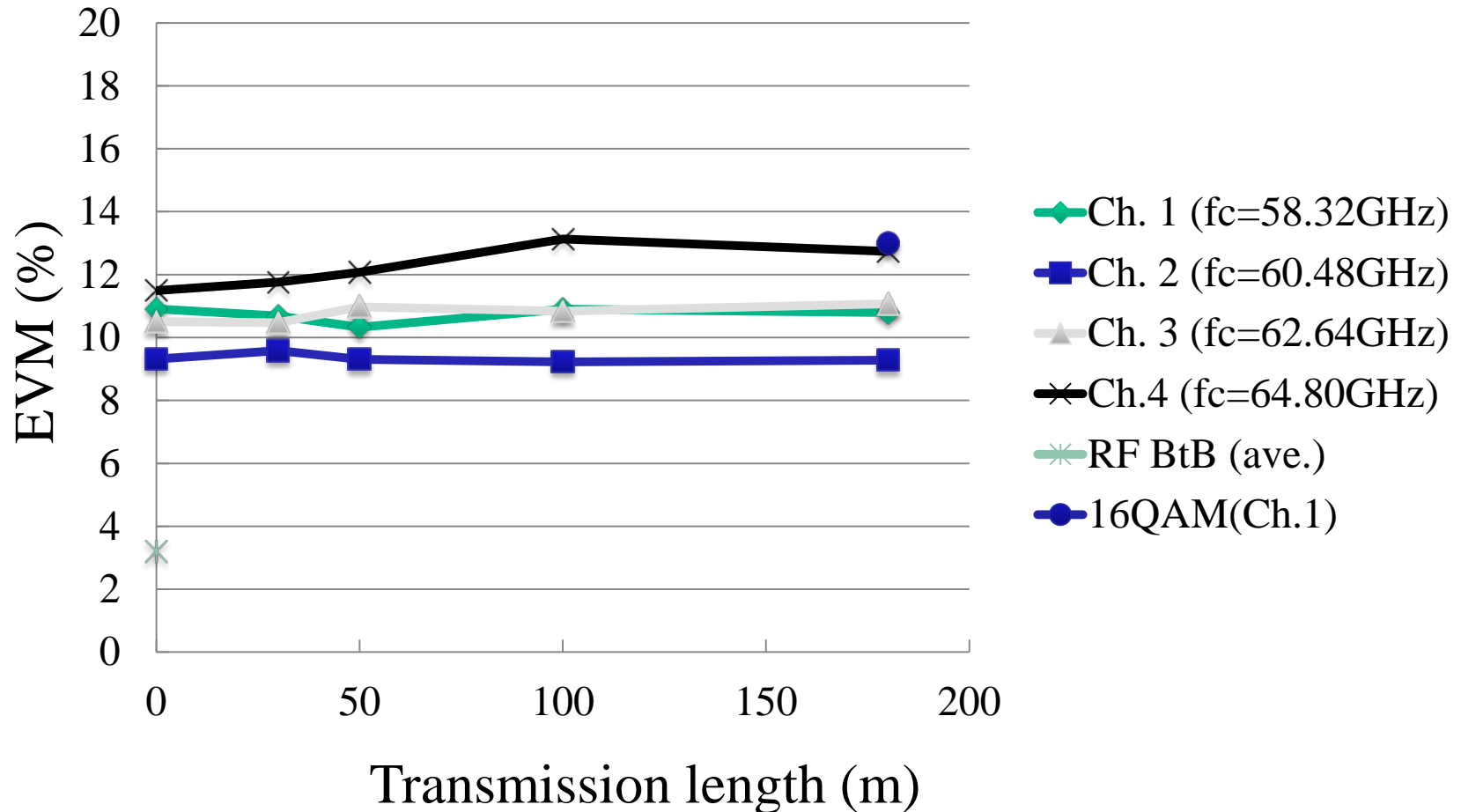

Delay Time of RoF Relay Link

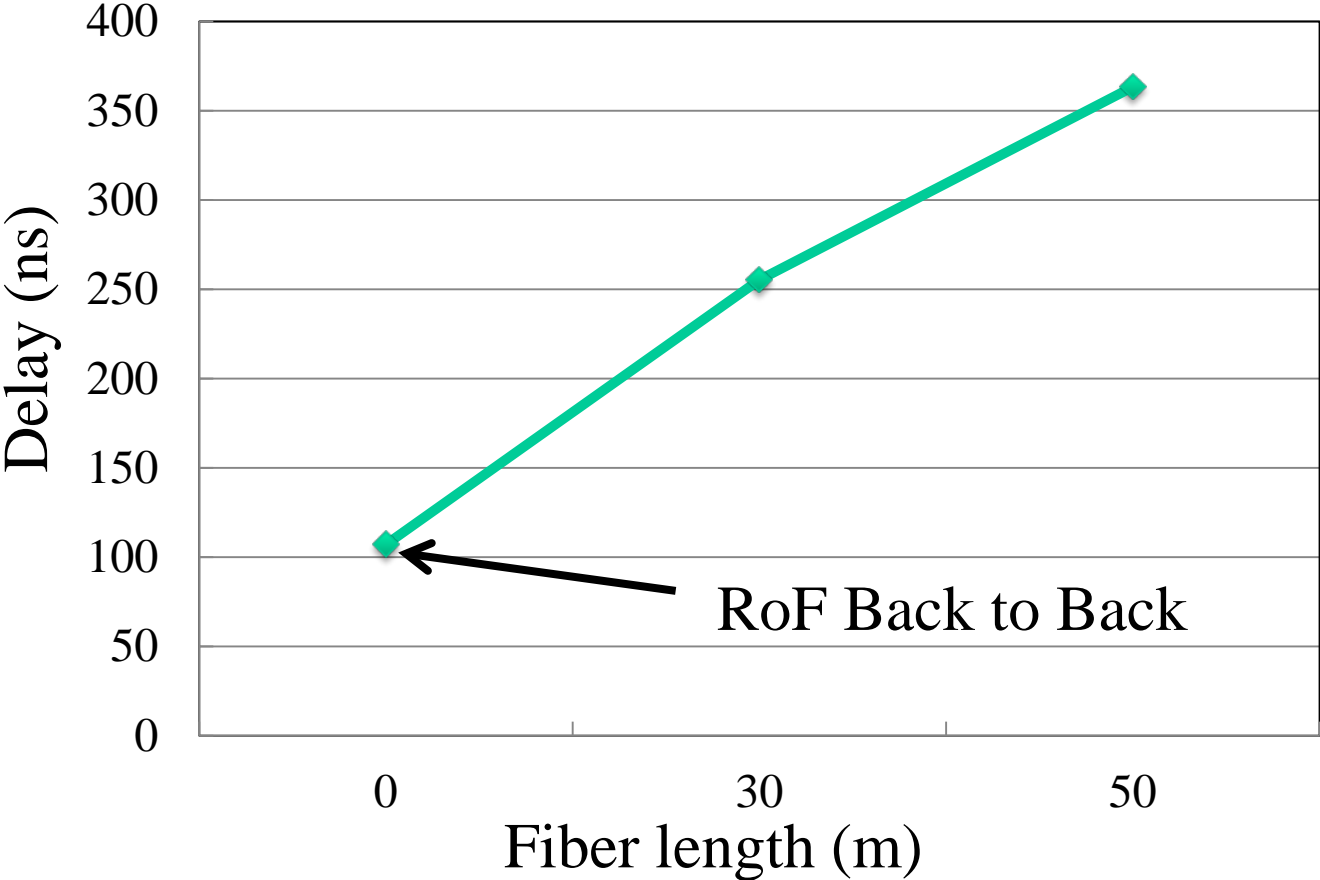

Spurious Free Dynamic Range of RoF Relay Link

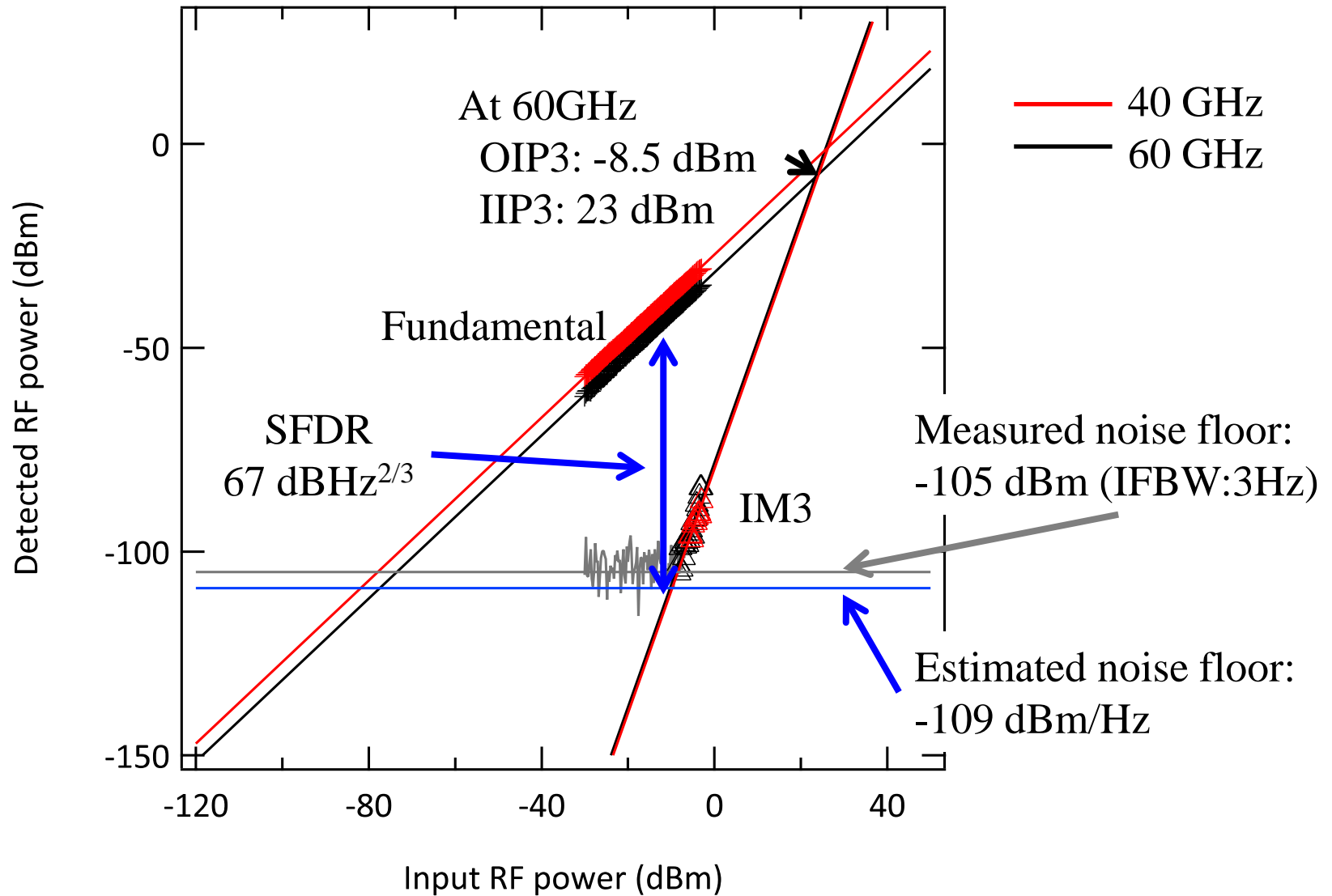

Level Diagram of RoF Relay Link

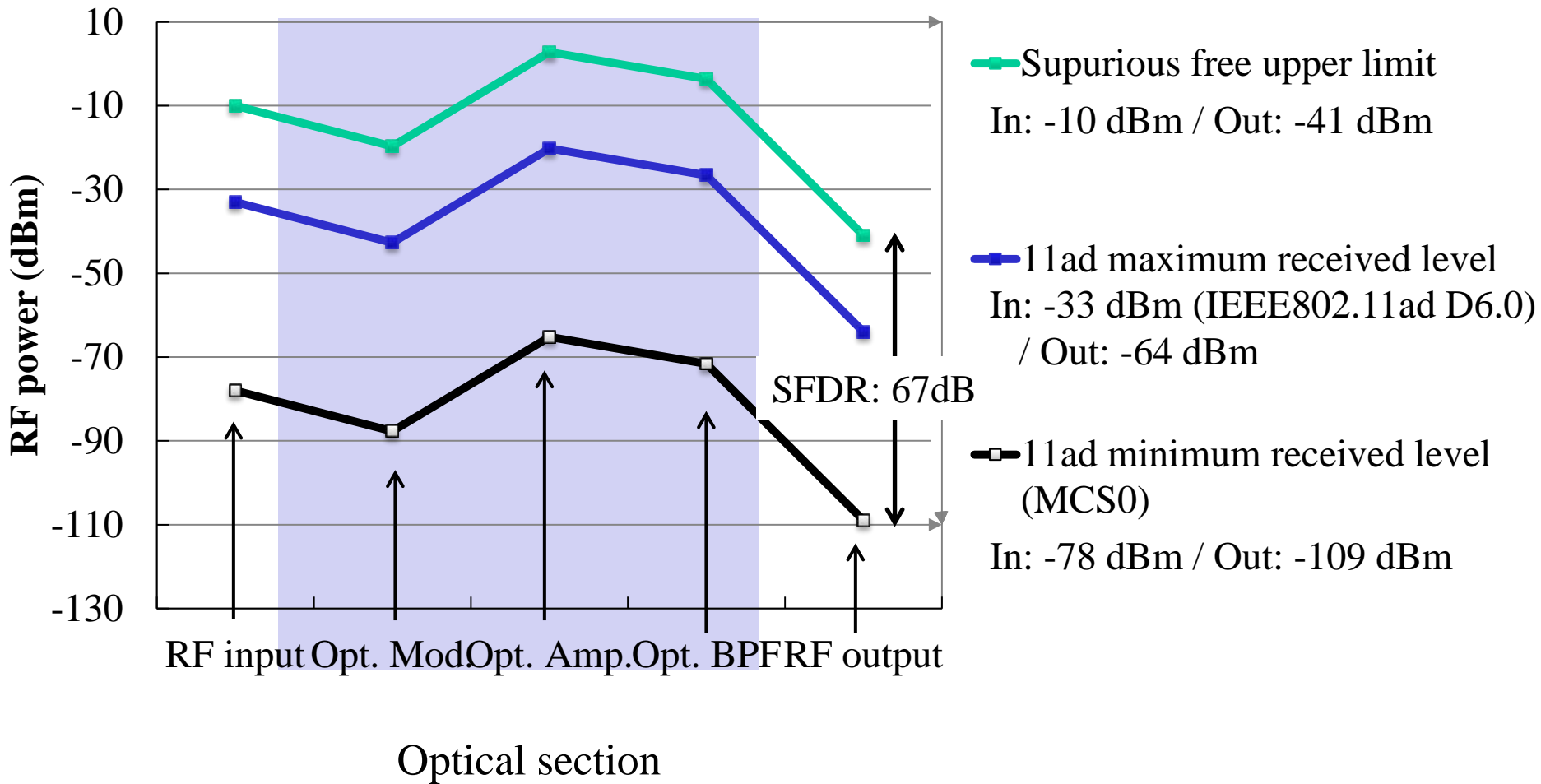

Experimental Setup 3 : SFDR of RoF link with head- and post-amplifier.

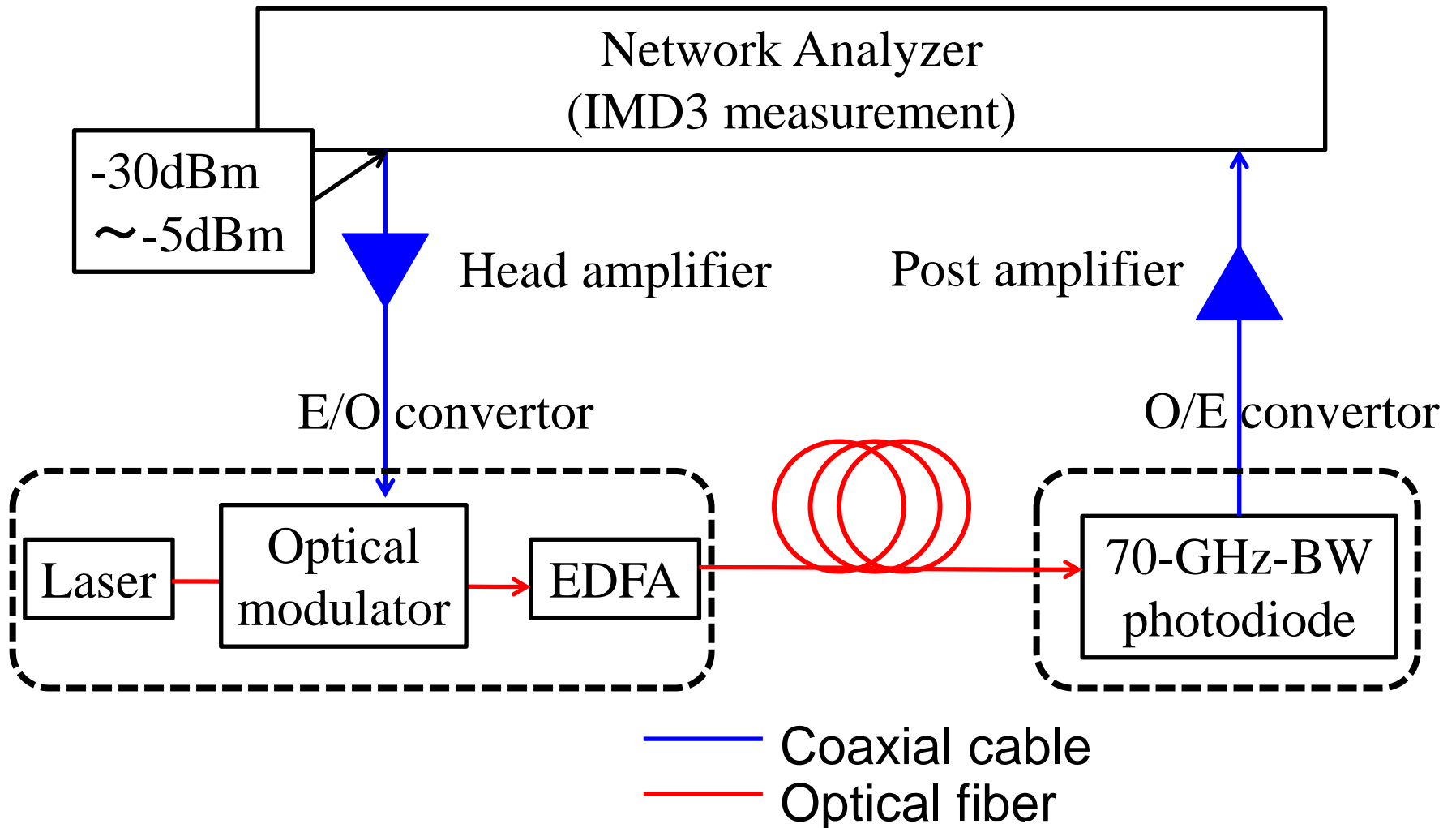

Improved SFDR of RoF Relay Link with Coaxial/WG Amplifiers

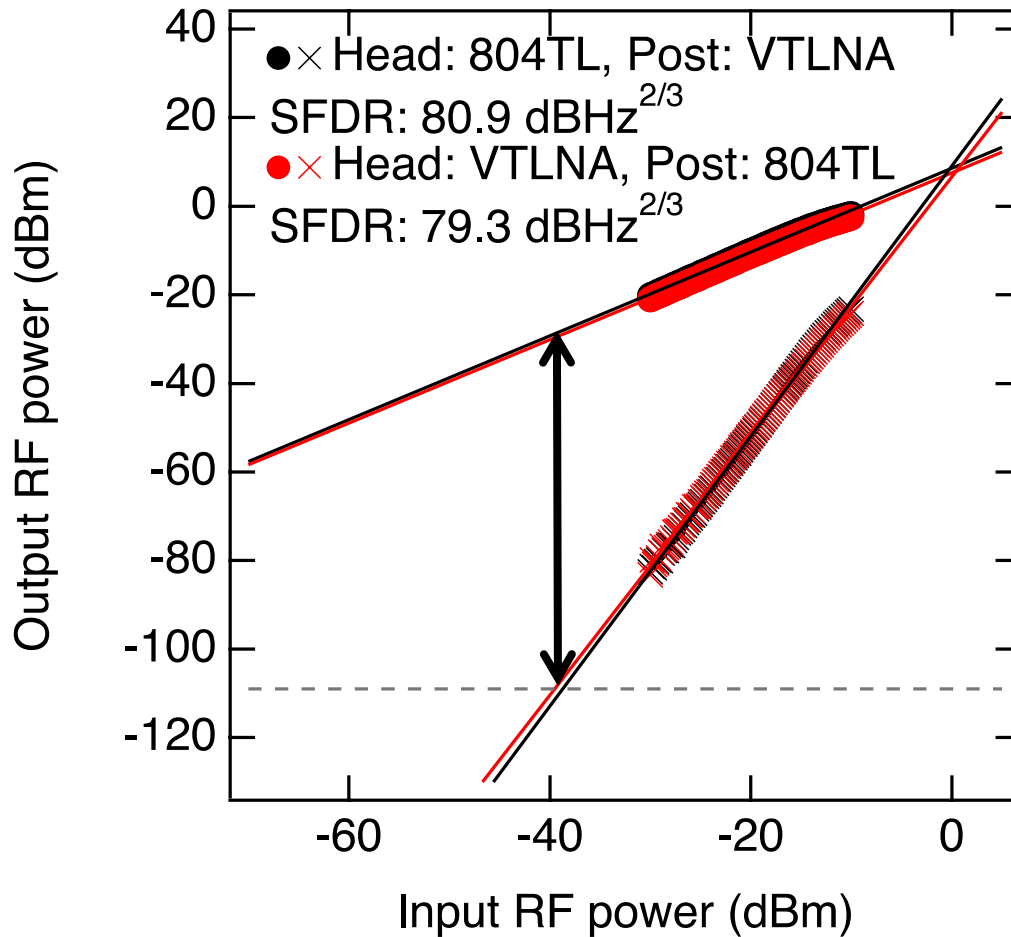

SFDR
~ 80 dBHz^{2/3}

AP-MG RT-RoF RL-MG RT-STA Uplink/Downlink

- No additional requirement for Beamforming Training -
- No frequency interference among STAs due to CSAM/TDMA -

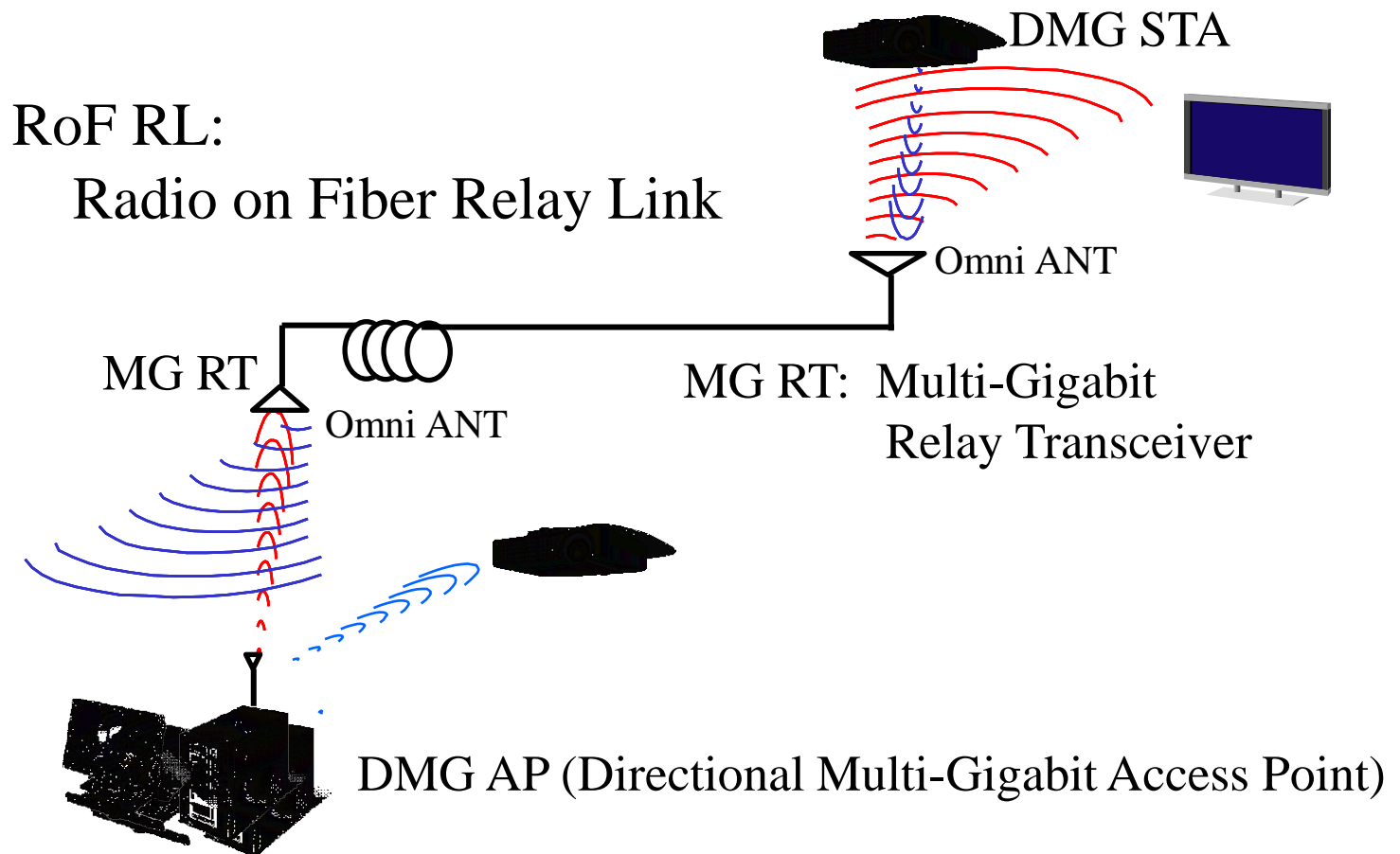

Block Diagram for Bi-directional MG RT Link 1

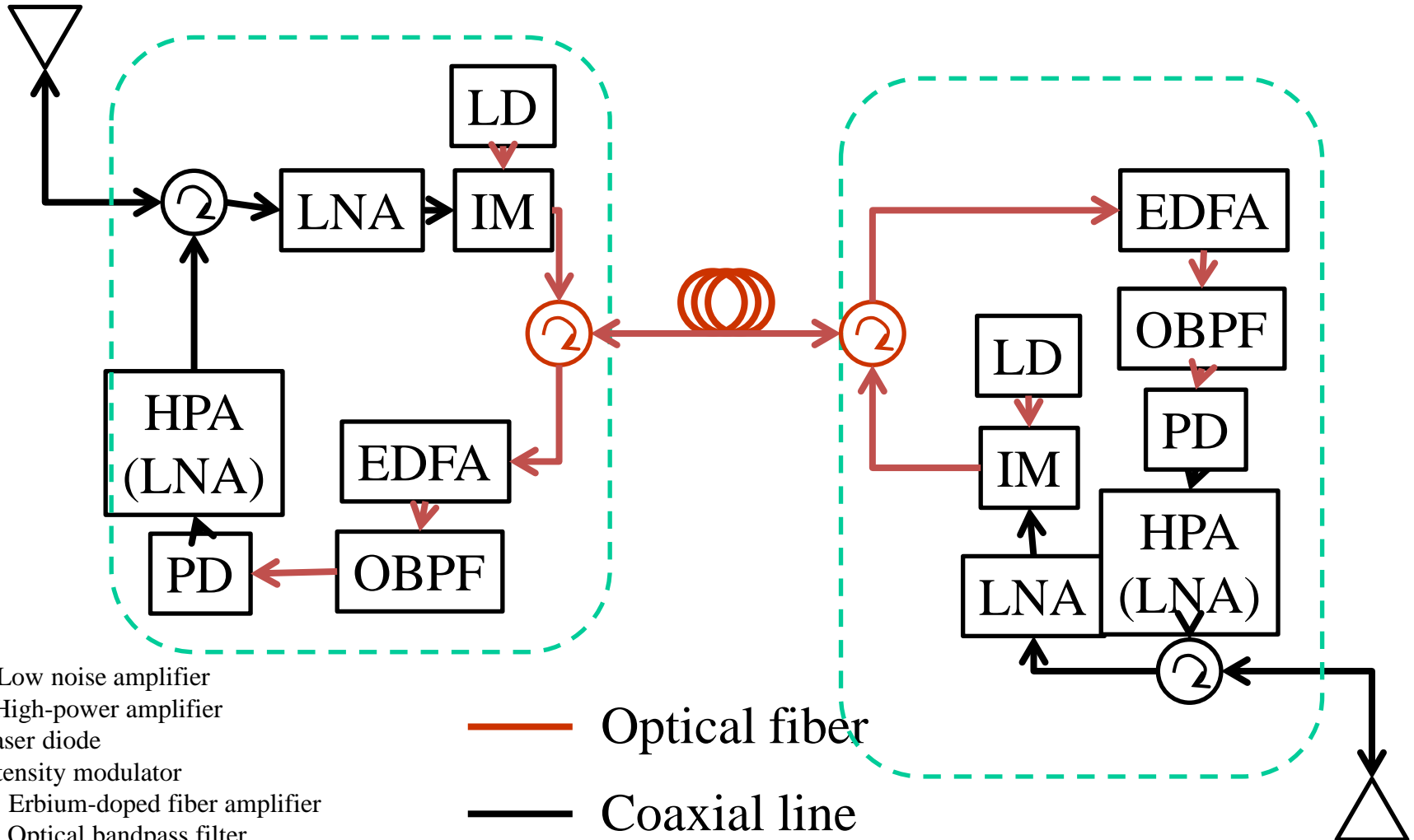

LNA: Low noise amplifier
 HPA: High-power amplifier
 LD: Laser diode
 IM: Intensity modulator
 EDFA: Erbium-doped fiber amplifier
 OBPF: Optical bandpass filter
 PD: Photodiode

— Optical fiber
 — Coaxial line

Block Diagram for Bi-directional MG RT Link 2

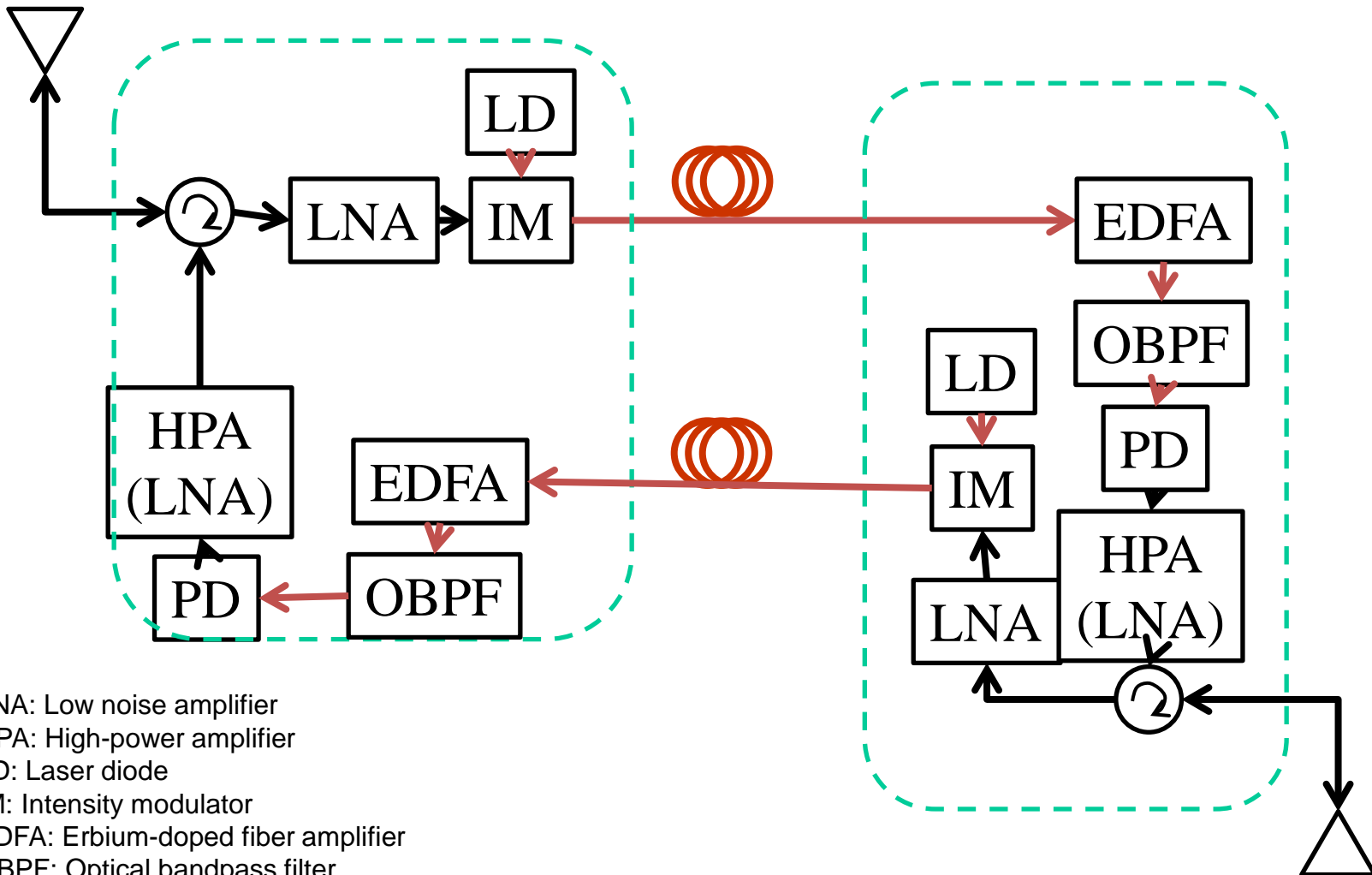

LNA: Low noise amplifier
 HPA: High-power amplifier
 LD: Laser diode
 IM: Intensity modulator
 EDFA: Erbium-doped fiber amplifier
 OBPF: Optical bandpass filter
 PD: Photodiode

Future issue : 60GHz HDTV Transmission via MG RT Link

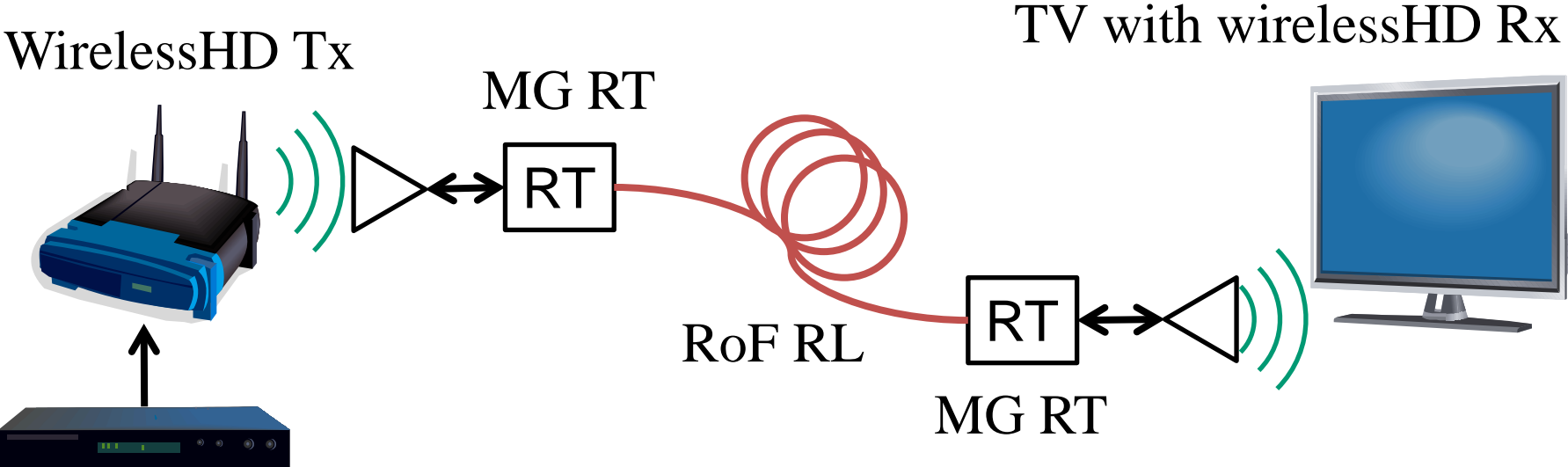

Standards related to Indoor Use of Optical Fiber Cable

- IEC60793-2-40 Ed.4.0 Optical fibers – Part 40: Product specifications – Sectional specification for category A4 multimode fibers

Technical Paper published by Optoelectronic Industry and Technology Development Association (Japan)

- TP02/BW-2011 - Optical fiber distribution system for apartment houses in FTTH
- TP01/BW -2011 - Optical fiber distribution system for detached houses in FTTH
- OITDA/TP03/BW-2012 - Optical fiber distribution system for customer premises

Summary

- RoF relay backhaul was proposed for Category 4 (Backhaul)
- RoF relay backhaul can extend wireless access area using E/O, O/E and optical fiber without any additional requirements.
- Data transmission experiment of RoF relay link using 802.11ad signal were presented and EVM of transmitted signals are less 14 %.
- Additional delay time caused by RoF relay link is about 350 ns at a fibre cable length of 50 m.
- Maximum length of fibre cable is about 100 m taking into account CCA (Clear Channel Assessment).
- Spurious free dynamic range of RoF relay link is improved up to 80 dBHz^{3/2}.
- WirelessHD devices will be connected through RoF relay link.

Acknowledgments: This work was supported in part by “The research and development project for the expansion of radio spectrum resources” of the Ministry of Internal Affairs and Communications in Japan